

# GYNO INFO

## INTRAUTERINE INSEMINATION CATHETER RANGE

PRODUCT	ORDER NUMBER
IUI	#4220
IUI Memo	#4220 Memo
IUI Plus	#4220 Plus
Smooze IUI	#4225
Smooze IUI Medium	#4225 M
Smooze IUI Long	#4225 L
Seminor Rigid	#4502 A
Seminor Flexible	#4502 B

GMP Belgium IUI Range 04/2011



Gynetics Medical Products n.v.  
Rembert Dodoensstraat 51 / 3920 Lommel, Belgium  
tel. +32 11 64 58 72 / fax +32 11 64 06 77  
info@gynetics.be / www.gynetics.be

**GYNETICS**<sup>®</sup>  
Practise better Medicine

# IUI

## UTERINE INSEMINATOR FOR WASHED SPERMATOZOA

The IUI is an intrauterine insemination catheter with two lateral distal ports for optimal sperm distribution.

### FEATURES

- positioner to prevent damage to fundus
- two lateral ports at distal end for optimal sperm distribution
- arrows on handle to indicate lateral ports at distal end
- markings on the outer tube
- handle with luer lock for a more secure fitting to syringes



ORIGINAL PICTURE

### GYNO INFO IUI

Length	206 mm (± 2 mm)
Tube OD	1.85 mm (± 0.10 mm)
Sterile	sterilized by radiation
Packaging	125/shipping box
Quality control	MEA and LAL
Order number	#4220 



GMP Belgium IUI 04/2011



Gynetics Medical Products n.v.  
Rembert Dodoensstraat 51 / 3920 Lommel, Belgium  
tel. +32 11 64 58 72 / fax +32 11 64 06 77  
info@gynetics.be / www.gynetics.be

**GYNETICS**<sup>®</sup>  
Practise better Medicine

# IUI MEMO

## UTERINE INSEMINATOR FOR WASHED SPERMATOZOA WITH MEMORY FUNCTION

The IUI Memo is an intrauterine insemination catheter with MEMO function, which proactively enables the distal tip to bend according to cervical flexion.

### FEATURES

- positioner to prevent damage to fundus
- two lateral ports at distal end for optimal sperm distribution
- arrows on handle to indicate lateral ports at distal end
- markings on outer tube
- memory function
- handle with luer lock for a more secure fitting to syringes



ORIGINAL PICTURE

### GYNO INFO IUI MEMO

Length	206 mm (± 2 mm)
Tube OD	1.85 mm (± 0.10 mm)
Sterile	sterilized by radiation
Packaging	125/shipping box
Quality control	MEA and LAL
Order number	#4220 Memo 

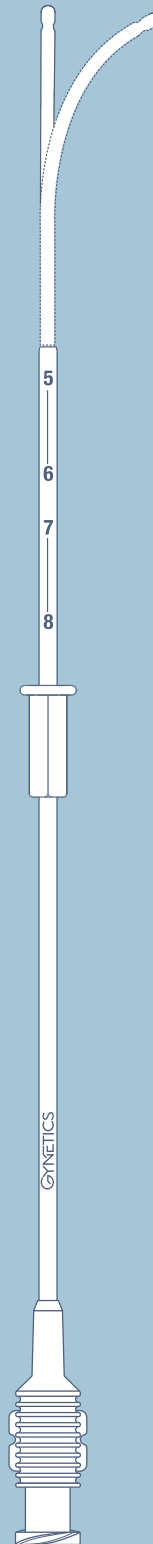

GMP Belgium IUI Memo 04/2011



Gynetics Medical Products n.v.  
Rembert Dodoensstraat 51 / 3920 Lommel, Belgium  
tel. +32 11 64 58 72 / fax +32 11 64 06 77  
info@gynetics.be / www.gynetics.be

**GYNETICS**<sup>®</sup>  
Practise better Medicine

# IUI PLUS

## UTERINE INSEMINATOR FOR WASHED SPERMATOZOA WITH MANDREL

The IUI Plus is a set for difficult cervical passage, consisting of two parts:

- A) Loading catheter
- B) Mandrel

### FEATURES

- positioner for depth adjustment
- a combination of a soft, flexible intrauterine catheter and a solid cervix catheter
- markings on outer tube for easy positioning
- mandrel to prevent mucus to enter the loading catheter
- handle with luer lock for a more secure fitting to syringes

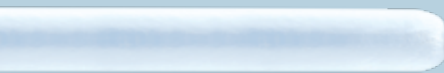

ORIGINAL PICTURE

### GYNO INFO IUI PLUS

Length	A) 216 mm ( $\pm$ 3 mm) B) 240 mm ( $\pm$ 2 mm)
Tube OD	A) 1.60 mm ( $\pm$ 0.10 mm) B) 1.00 mm ( $\pm$ 0.05 mm)
Total volume	A) 0.42 ml
Total volume minus hub	A) 0.258 ml
Sterile	sterilized by radiation
Packaging	75/shipping box
Quality control	MEA and LAL
Order number	#4220 Plus 

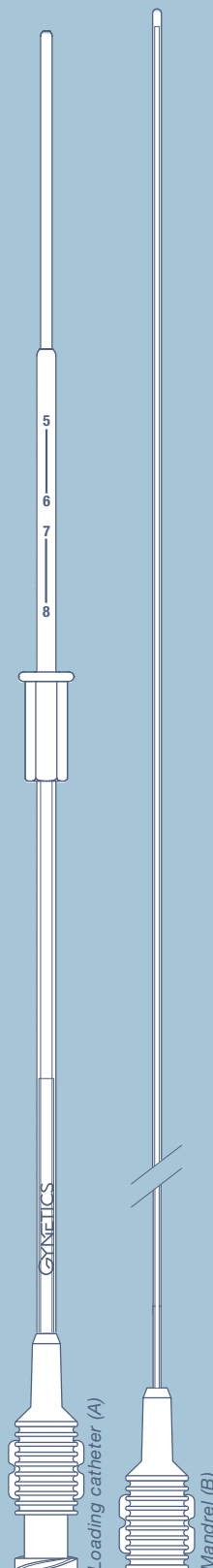

GMP Belgium IUI Plus 04/2011



Gynetics Medical Products n.v.  
Rembert Dodoensstraat 51 / 3920 Lommel, Belgium  
tel. +32 11 64 58 72 / fax +32 11 64 06 77  
info@gynetics.be / www.gynetics.be

**GYNETICS**<sup>®</sup>  
Practise better Medicine

# SMOOZE IUI

## FLEXIBLE INTRAUTERINE INSEMINATION CANNULA

The Smooze IUI is a flexible intrauterine insemination catheter with a smooth tip for less traumatic inseminations.

### FEATURES

- smooth tip with one distal side hole
- very flexible and therefore less traumatic
- handle with luer lock for a more secure fitting to syringes
- available in 3 lengths:

- A) Short 7 cm (not including handle)
- B) Medium 14 cm (not including handle)
- C) Long 20 cm (not including handle)



ORIGINAL PICTURE

### GYNO INFO SMOOZE IUI

Length : A) 100 mm ( $\pm$  2 mm)  
B) 169 mm ( $\pm$  2 mm)  
C) 230 mm ( $\pm$  2 mm)



Tube OD : 2 mm ( $\pm$  0.05 mm)

Volume : A) min. 0.030 ml  
B) min. 0.057 ml  
C) min. 0.080 ml

Sterile : ETO sterilized

Packaging : A) 125/shipping box  
B) 125/shipping box  
C) 75/shipping box

Quality control : MEA and LAL

Order number : A) #4225   
B) #4225 M   
C) #4225 L 

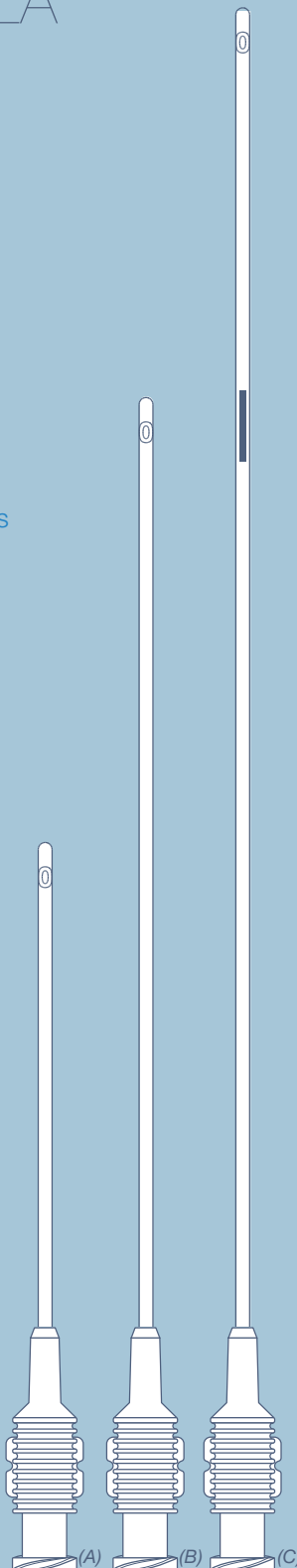

GMP Belgium Smooze IUI 04/2011



Gynetics Medical Products n.v.  
Rembert Dodoensstraat 51 / 3920 Lommel, Belgium  
tel. +32 11 64 58 72 / fax +32 11 64 06 77  
info@gynetics.be / www.gynetics.be

**GYNETICS**<sup>®</sup>  
Practise better Medicine

# SEMINOR RIGID/FLEXIBLE

## MULTI-PURPOSE CANNULA FOR ASSISTED HUMAN REPRODUCTION



- A) The Seminor Rigid is a semi-rigid catheter for intrauterine and cervical insemination.
- B) The Seminor Flexible is a catheter for intrauterine and cervical insemination.

### FEATURES

- the Seminor Rigid (A) can be shaped according to the degree of uterine flexion
- the Seminor Flexible (B) enables easy insertion with minimal patient discomfort
- the conical proximal end closes the cervix adequately for maximum sperm transfer
- as result of a direct connection between Seminor and syringe, the loss of spermatozoa during the transfer is minimized



### GYNO INFO SEMINOR RIGID/FLEXIBLE

Length	48 mm ( $\pm$ 0.5 mm)
Volume	min. 0.098 ml
Sterile	sterilized by radiation
Packaging	125/shipping box
Quality control	MEA and LAL
Order number	A) #4502 A  B) #4502 B 

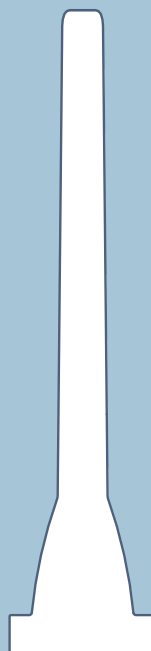

GMP Belgium Seminor 04/2011



Gynetics Medical Products n.v.  
Rembert Dodoensstraat 51 / 3920 Lommel, Belgium  
tel. +32 11 64 58 72 / fax +32 11 64 06 77  
info@gynetics.be / www.gynetics.be

**GYNETICS**<sup>®</sup>  
Practise better Medicine

# GYNO INFO

## EMBRYO TRANSFER CATHETER RANGE

### EMBRYO TRANSFER CATHETERS FOR EASY TRANSFER

PRODUCT	ORDER NUMBER
Emtrac A	#4219 A
Emtrac Delphin	#4219 Delphin
Semtrac C	#2000 C

### EMBRYO TRANSFER CATHETER SETS FOR DIFFICULT TRANSFER

PRODUCT	ORDER NUMBER
Emtrac Set	#4219 Set
Semtrac Set 4.2	#2000 Set 4.2
Semtrac Set 5	#2000 Set 5
Semtrac Set 5 Trial	#2000 Set 5 T
Semtrac Set W-180	#2000 W-180
Semtrac Set W-180 Trial	#2000 W-180 T
Semtrac Set W-240	#2000 W-240
Semtrac Set W-240 Trial	#2000 W-240 T
The Tulip	#4000 The Tulip
The Tulip Memo	#4000 Memo

### REUSABLE EMBRYO TRANSFER CATHETERS FOR DIFFICULT TRANSFER

PRODUCT	ORDER NUMBER
Gyneflex	#Gyneflex-200 #Gyneflex-200FC #Gyneflex-240

GMP Belgium ET Range 05/2013



Gynetics Medical Products n.v.  
Rembert Dodoensstraat 51 / 3920 Lommel, Belgium  
tel. +32 11 64 58 72 / fax +32 11 64 06 77  
info@gynetics.be / www.gynetics.be

**GYNETICS**<sup>®</sup>  
Practise better Medicine

# EMTRAC A

## EMBRYO TRANSFER CATHETER WITH POSITIONER

The Emtrac A is a combination of a soft, flexible intrauterine catheter and a solid cervix catheter.

### FEATURES

- positioner for depth adjustment
- a combination of a soft, flexible intrauterine catheter and a solid cervix catheter
- markings on outer tube for easy positioning
- handle with luer lock for a more secure fitting to syringes
- also implemented for intrauterine insemination, when a thinner cannula is required

ORIGINAL PICTURE

### GYNO INFO EMTRAC A

Length	216 mm ( $\pm$ 3 mm)
Tube OD	1.60 mm ( $\pm$ 0.10 mm)
Total volume	0.42 ml
Total volume minus hub	0.258 ml
Sterile	sterilized by radiation
Packaging	125/shipping box
Quality control	MEA and LAL
Order number	#4219 A 

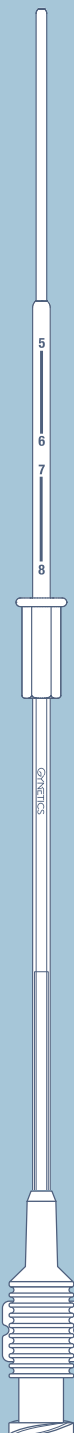

GMP Belgium Emtrac A 04/2011



Gynetics Medical Products n.v.  
Rembert Dodoensstraat 51 / 3920 Lommel, Belgium  
tel. +32 11 64 58 72 / fax +32 11 64 06 77  
info@gynetics.be / www.gynetics.be

**GYNETICS**<sup>®</sup>  
Practise better Medicine



# EMTRAC DELPHIN

## EMBRYO TRANSFER CATHETER WITH POSITIONER AND SOFT UTERINE CATHETER

The combination of a soft flexible intrauterine catheter and a solid cervix catheter creates an universal catheter for easy insertion in the most difficult cervical tract.

### FEATURES

- positioner to prevent damage to fundus
- microscopic quality inspection of each tip
- markings on the outer cannula indicating uterine depth
- extra soft uterine catheter to ensure safe insertion through cervix
- handle with luer lock for a more secure fitting to syringes



ORIGINAL PICTURE

### GYNO INFO EMTRAC DELPHIN

Length	210 mm (± 3 mm)
Tube OD	2.00 mm (± 0.20 mm)
Total volume	0.23 ml
Total volume minus hub	0.072 ml
Sterile	ETO sterilized
Packaging	75/shipping box
Quality control	MEA and LAL
Order number	#4219 Delphin 

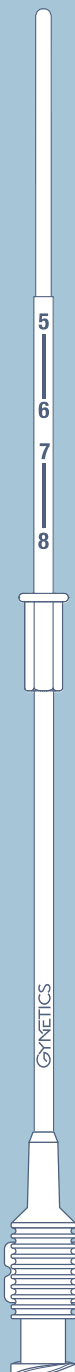

GMP Belgium Emtrac Delphin 04/2011



Gynetics Medical Products n.v.  
Rembert Dodoensstraat 51 / 3920 Lommel, Belgium  
tel. +32 11 64 58 72 / fax +32 11 64 06 77  
info@gynetics.be / www.gynetics.be

**GYNETICS**<sup>®</sup>  
Practise better Medicine

# SEMTRAC C

## SOFT EMBRYO TRANSFER CATHETER

The Semtrac C is a soft embryo transfer catheter.

### FEATURES

- soft bullet shaped tip to minimize trauma
- individual microscopic quality inspection
- one piece economical catheter
- markings to indicate depth
- metal tube inside for better control
- handle with luer lock for a more secure fitting to syringes

ORIGINAL PICTURE

### GYNO INFO SEMTRAC C

Length	252 mm ( $\pm$ 2 mm)
Tube OD	1.70 mm ( $\pm$ 0.05 mm)
Total volume	0.20 ml
Total volume minus hub	0.065 ml
Sterile	ETO sterilized
Packaging	75/shipping box
Quality control	MEA and LAL
Order number	#2000 C 



GMP Belgium Semtrac C 04/2011



Gynetics Medical Products n.v.  
Rembert Dodoensstraat 51 / 3920 Lommel, Belgium  
tel. +32 11 64 58 72 / fax +32 11 64 06 77  
info@gynetics.be / www.gynetics.be

**GYNETICS**<sup>®</sup>  
Practise better Medicine

# EMTRAC SET

## EMBRYO TRANSFER CATHETER WITH POSITIONER

The Emtrac Set is a set for difficult cervical passage, consisting of three parts:

- A) Guiding catheter
- B) Mandrel
- C) Loading catheter

### FEATURES

- positioner for depth adjustment
- a combination of a soft, flexible intrauterine catheter and a solid cervix catheter
- markings on outer tube for easy positioning
- soft loading catheter to minimize trauma
- handle with luer lock for a more secure fitting to syringes

ORIGINAL PICTURE

### GYNO INFO EMTRAC SET

Length	A) 216 mm (± 3 mm) B) 240 mm (± 2 mm) C) 266 mm (± 2 mm)
Tube OD	A) 1.60 mm (± 0.10 mm) B) 1.00 mm (± 0.05 mm) C) 1.00 mm (± 0.05 mm)
Total volume	C) 0.20 ml
Total volume minus hub	C) 0.069 ml
Sterile	sterilized by radiation
Packaging	75/shipping box
Quality control	MEA and LAL
Order number	#4219 Set 

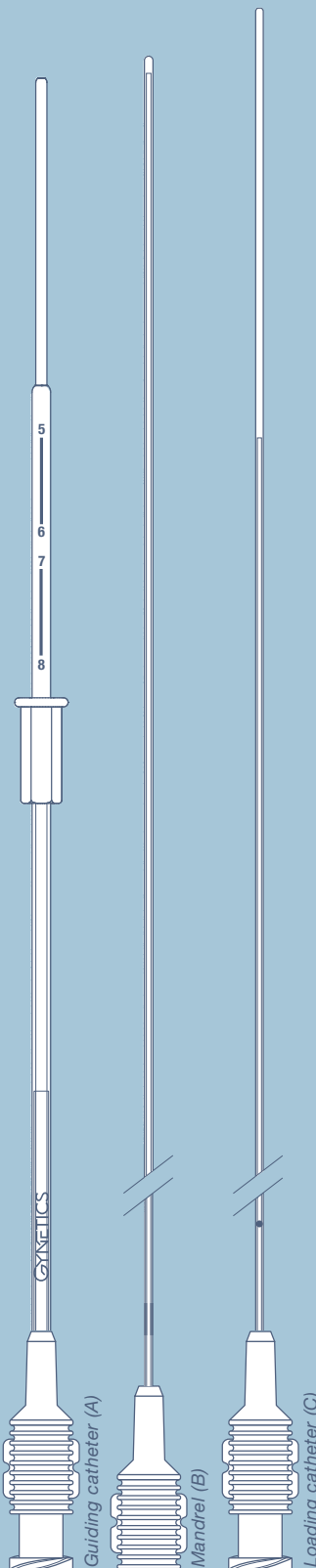

GMP Belgium Emtrac Set 04/2011



Gynetics Medical Products n.v.  
Rembert Dodoensstraat 51 / 3920 Lommel, Belgium  
tel. +32 11 64 58 72 / fax +32 11 64 06 77  
info@gynetics.be / www.gynetics.be

**GYNETICS**<sup>®</sup>  
Practise better Medicine

# SEMTRAC SET 4.2

## SOFT EMBRYO TRANSFER CATHETER

The Semtrac Set is a soft embryo transfer catheter set for difficult embryo transfers.

### FEATURES

- soft bullet shaped tip to minimize trauma
- individual microscopic quality inspection
- three piece catheter for difficult transfers
- 5 free mandrels, to preshape the guiding catheter, in every box of 25 pieces
- reinforced shaft of loading catheter for optimal control
- handle with luer lock for a more secure fitting to syringes



ORIGINAL PICTURE

### GYNO INFO SEMTRAC SET 4.2

Guiding catheter (A) length 158 mm ( $\pm$  2 mm)  
tube OD 2.55 mm ( $\pm$  0.05 mm)

Loading catheter (C) length 232 mm ( $\pm$  2 mm)  
tube OD 1.70 mm ( $\pm$  0.05 mm)  
total volume 0.23 ml  
total volume minus hub 0.081 ml

Sterile ETO sterilized

Packaging 75/shipping box

Quality control MEA and LAL

Order number #2000 Set 4.2 

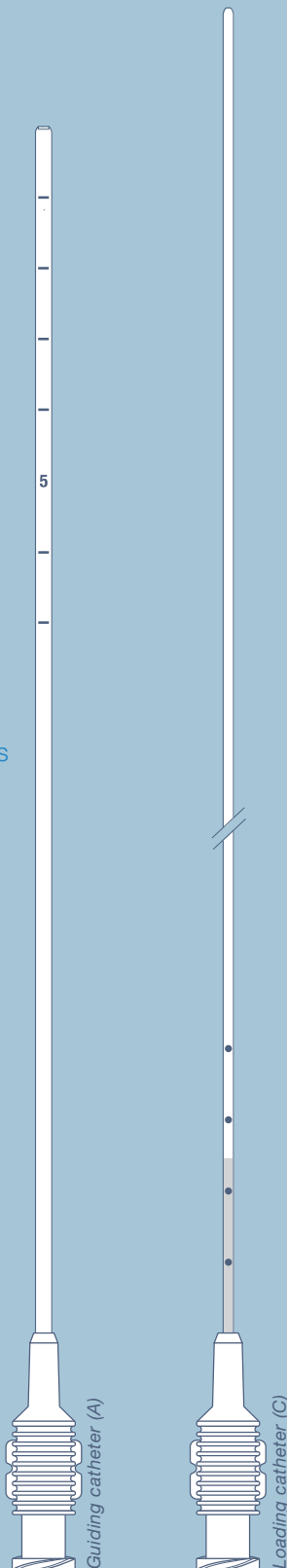

GMP Belgium Semtrac Set 4.2 04/2011



Gynetics Medical Products n.v.  
Rembert Dodoensstraat 51 / 3920 Lommel, Belgium  
tel. +32 11 64 58 72 / fax +32 11 64 06 77  
info@gynetics.be / www.gynetics.be

**GYNETICS**<sup>®</sup>  
Practise better Medicine

# SEMTRAC SET 5

## SOFT EMBRYO TRANSFER CATHETER

The Semtrac Set is a soft embryo transfer catheter set for difficult embryo transfers.

### FEATURES

- soft bullet shaped tip to minimize trauma
- individual microscopic quality inspection
- three piece catheter for difficult transfers
- 5 free mandrels, to preshape the guiding catheter, in every box of 25 pieces
- reinforced shaft of loading catheter for optimal control
- handle with luer lock for a more secure fitting to syringes
- trial catheter set available for cervix examination prior to embryo transfer consisting of a guiding catheter and a soft closed-end trial catheter



ORIGINAL PICTURE

### GYNO INFO SEMTRAC SET 5

Guiding catheter (A) length 178 mm ( $\pm$  2 mm)  
tube OD 2.55 mm ( $\pm$  0.05 mm)

Loading catheter (C) length 252 mm ( $\pm$  2 mm)  
tube OD 1.70 mm ( $\pm$  0.05 mm)  
total volume 0.22 ml  
total volume minus hub 0.089 ml

Sterile ETO sterilized

Packaging 75/shipping box

Quality control MEA and LAL

Order number

- Semtrac Set 5 #2000 Set 5 ☒

- Semtrac Set 5 Trial #2000 Set 5 T ☒

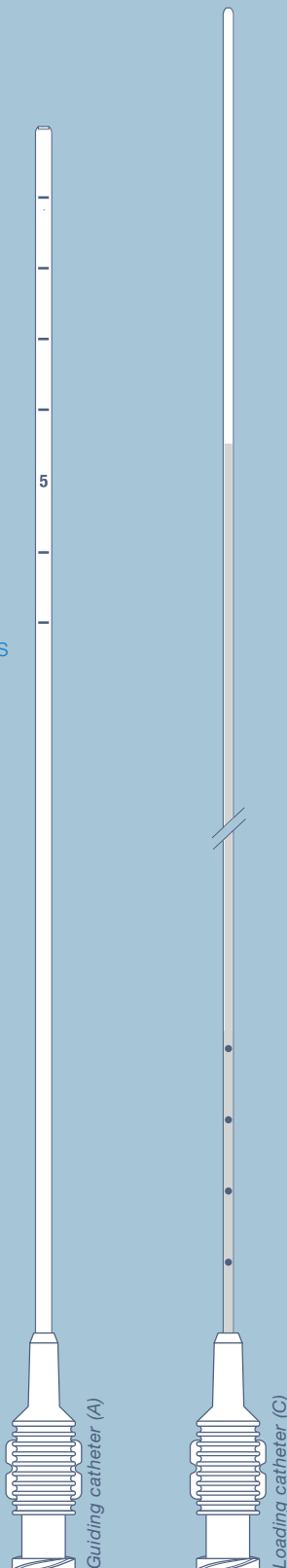

GMP Belgium Semtrac Set 5 12/2012



Gynetics Medical Products n.v.  
Rembert Dodoensstraat 51 / 3920 Lommel, Belgium  
tel. +32 11 64 58 72 / fax +32 11 64 06 77  
info@gynetics.be / www.gynetics.be

**GYNETICS**<sup>®</sup>  
Practise better Medicine

# SEMTRAC SET W-180

## SOFT EMBRYO TRANSFER CATHETER

The Semtrac Set is a soft embryo transfer catheter set for difficult embryo transfers.

### FEATURES

- soft bullet shaped tip to minimize trauma
- individual microscopic quality inspection
- 5 free mandrels, to preshape the guiding catheter, in every box of 25 pieces
- handle with luer lock for a more secure fitting to syringes
- trial catheter set available for cervix examination prior to embryo transfer consisting of a guiding catheter and a soft closed-end trial catheter

ORIGINAL PICTURE

### GYNO INFO SEMTRAC SET W-180

Guiding catheter (A) length 141 mm ( $\pm$  2 mm)  
tube OD 2.55 mm ( $\pm$  0.05 mm)

Loading catheter (C) length 214 mm ( $\pm$  2 mm)  
tube OD 1.70 mm ( $\pm$  0.05 mm)  
total volume 0.23 ml  
total volume minus hub 0.074 ml

Sterile ETO sterilized

Packaging 75/shipping box

Quality control MEA and LAL

Order number

- Semtrac Set W-180 #2000 W-180 ☒
- Semtrac Set W-180 Trial #2000 W-180 T ☒

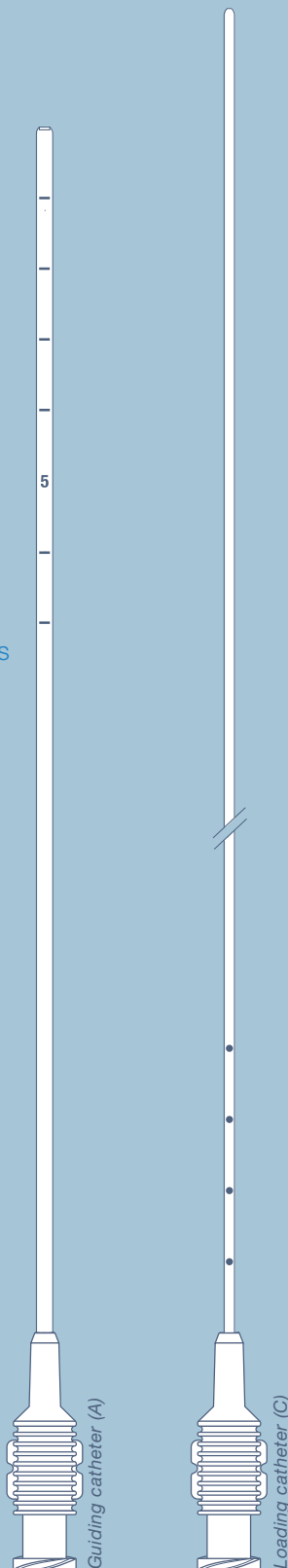

GMP Belgium Semtrac W-180 12/2012



Gynetics Medical Products n.v.  
Rembert Dodoensstraat 51 / 3920 Lommel, Belgium  
tel. +32 11 64 58 72 / fax +32 11 64 06 77  
info@gynetics.be / www.gynetics.be

**GYNETICS**<sup>®</sup>  
Practise better Medicine

# SEMTRAC SET W-240

## SOFT EMBRYO TRANSFER CATHETER

The Semtrac Set is a soft embryo transfer catheter set for difficult embryo transfers.

### FEATURES

- soft bullet shaped tip to minimize trauma
- individual microscopic quality inspection
- 5 free mandrels, to preshape the guiding catheter, in every box of 25 pieces
- handle with luer lock for a more secure fitting to syringes
- trial catheter set available for cervix examination prior to embryo transfer consisting of a guiding catheter and a soft closed-end trial catheter



ORIGINAL PICTURE

### GYNO INFO SEMTRAC SET W-240

Guiding catheter (A) length 203 mm ( $\pm$  2 mm)  
tube OD 2.55 mm ( $\pm$  0.05 mm)

Loading catheter (C) length 277 mm ( $\pm$  2 mm)  
tube OD 1.70 mm ( $\pm$  0.05 mm)  
total volume 0.26 ml  
total volume minus hub 0.098 ml

Sterile ETO sterilized

Packaging 75/shipping box

Quality control MEA and LAL

Order number

- Semtrac Set W-240 #2000 W-240 
- Semtrac Set W-240 Trial #2000 W-240 T 

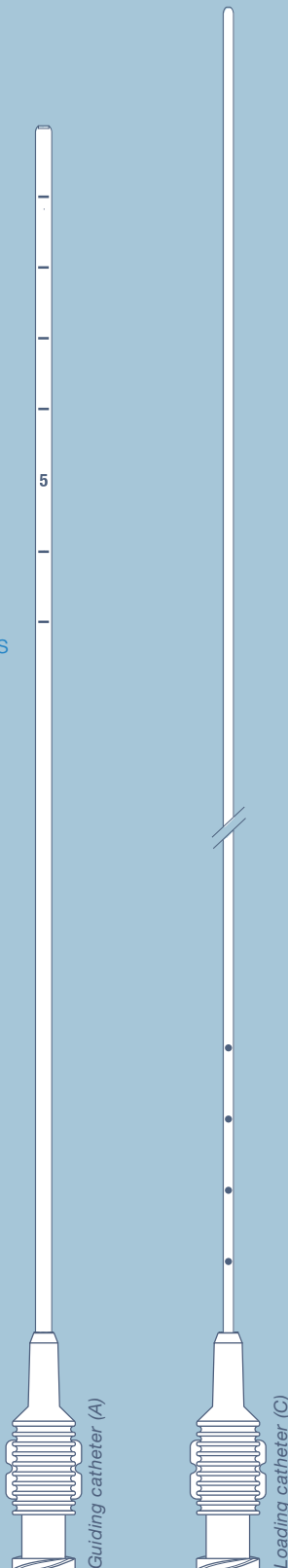

GMP Belgium Semtrac W-240 12/2012



# THE TULIP

## PRESHAPED EMBRYO TRANSFER CATHETER WITH TULIP SHAPED BULB

The Tulip is a set for difficult cervical passage, consisting of two parts: a guiding catheter (A) and a loading catheter (C).

### FEATURES

- preshaped guiding catheter, ideally curved for easy entry when uterus is flexed
- the Tulip tip enables easy atraumatic entry through the cervical canal
- positioner for depth adjustment
- markings on outer tube for easy positioning
- handle with luer lock fitting for a more secure connection to syringes
- reinforced metal support of loading catheter for optimal control
- arrow marking on outer tube for curve indication

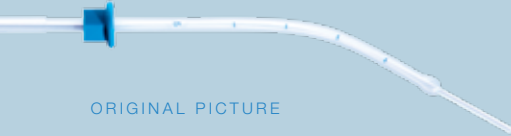

ORIGINAL PICTURE

### GYNO INFO THE TULIP

Length	A) 200 mm ( $\pm$ 2 mm) C) 266 mm ( $\pm$ 2 mm)
Tube OD	A) 2.20 mm ( $\pm$ 0.05 mm) C) 1.00 mm ( $\pm$ 0.05 mm)
Total volume	C) 0.21 ml
Total volume minus hub	C) 0.069 ml
Tulip bulb	3 mm
Sterile	sterilized by radiation
Packaging	75/shipping box
Quality control	MEA and LAL
Order number	#4000 The Tulip <sup>®</sup>

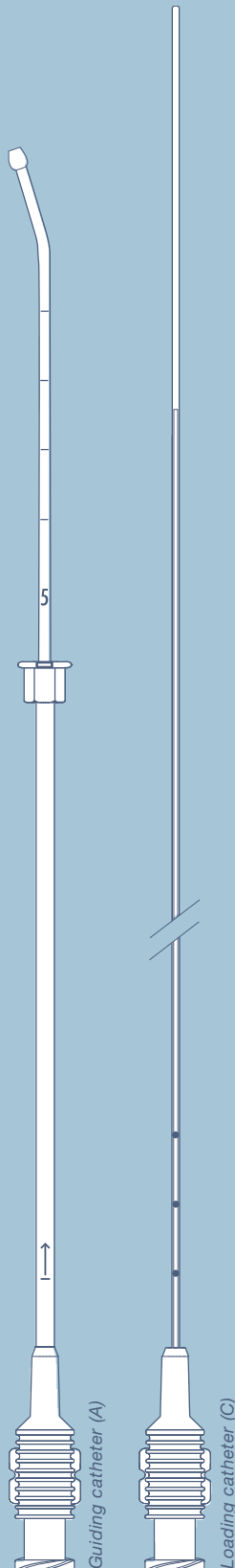

GMP Belgium The Tulip 04/2011



Gynetics Medical Products n.v.  
Rembert Dodoensstraat 51 / 3920 Lommel, Belgium  
tel. +32 11 64 58 72 / fax +32 11 64 06 77  
info@gynetics.be / www.gynetics.be

**GYNETICS**<sup>®</sup>  
Practise better Medicine



# THE TULIP MEMO

## EMBRYO TRANSFER CATHETER WITH TULIP SHAPED BULB

The Tulip is a set for difficult cervical passage, consisting of two parts: a guiding catheter (A) and a loading catheter (C).

### FEATURES

- the Tulip tip enables easy atraumatic entry through the cervical canal
- mandrel available for extra difficult transfers
- positioner for depth adjustment
- a combination of a soft, flexible intrauterine catheter and a solid cervix catheter with memory
- markings on outer tube for easy positioning
- memo function of the guiding catheter
- 5 free mandrels to preshape the guiding catheter in every box of 25 pieces
- handle with luer lock fitting for a more secure connection to syringes
- reinforced metal support of loading catheter for optimal control



ORIGINAL PICTURE

### GYNO INFO THE TULIP MEMO

Length	A) 200 mm ( $\pm$ 2 mm) C) 266 mm ( $\pm$ 2 mm)
Tube OD	A) 2.20 mm ( $\pm$ 0.05 mm) C) 1.00 mm ( $\pm$ 0.05 mm)
Total volume	C) 0.21 ml
Total volume minus hub	C) 0.069 ml
Tulip bulb	3 mm
Sterile	sterilized by radiation
Packaging	75/shipping box
Quality control	MEA and LAL
Order number	#4000 Memo 

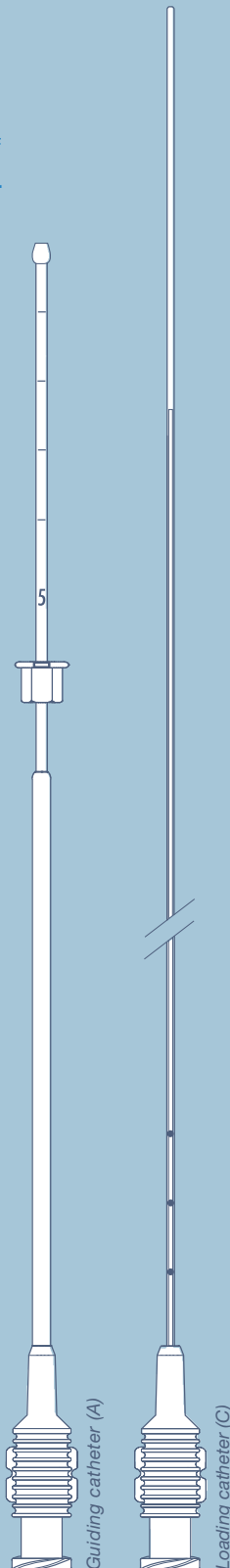

GMP Belgium The Tulip Memo 04/2011



Gynetics Medical Products n.v.  
Rembert Dodoensstraat 51 / 3920 Lommel, Belgium  
tel. +32 11 64 58 72 / fax +32 11 64 06 77  
info@gynetics.be / www.gynetics.be

**GYNETICS**<sup>®</sup>  
Practise better Medicine

# GYNEFLEX

## EMBRYO TRANSFER CATHETER FOR DIFFICULT EMBRYO TRANSFERS

The Gyneflex is a reusable economical embryo transfer catheter for difficult cervical passage.

### FEATURES

- visible markings for exact positioning
- combined with a single use embryo transfer catheter: Emtrac C-200 or -240
- bulb tip enables easy atraumatic cervical passage
- flexible end which enables it to follow the cervical canal
- flat curved version available in case of a less flexed uterus: #Gyneflex-200FC



ORIGINAL PICTURE

### GYNO INFO GYNEFLEX 200 & 240

Length	200 - 240 mm
Tube ID	1.10 mm
Tube OD	2.50/1.90 mm
Packaging	1/shipping box
Order number	#Gyneflex-200 #Gyneflex-200FC #Gyneflex-240

### GYNO INFO EMTRAC C-200 & C-240

Length	286 - 297 mm (± 2 mm)
Tube ID	0.60 mm (± 0.05 mm)
OD	1.00 mm (± 0.05 mm)
Total volume	0.207 ml - 0.210 ml
Total volume minus hub	0.075 ml - 0.078 ml
Sterile	sterilized by radiation
Packaging	75/shipping box
Quality control	MEA and LAL
Order number	#4219 C-200 ☺ #4219 C-240 ☺

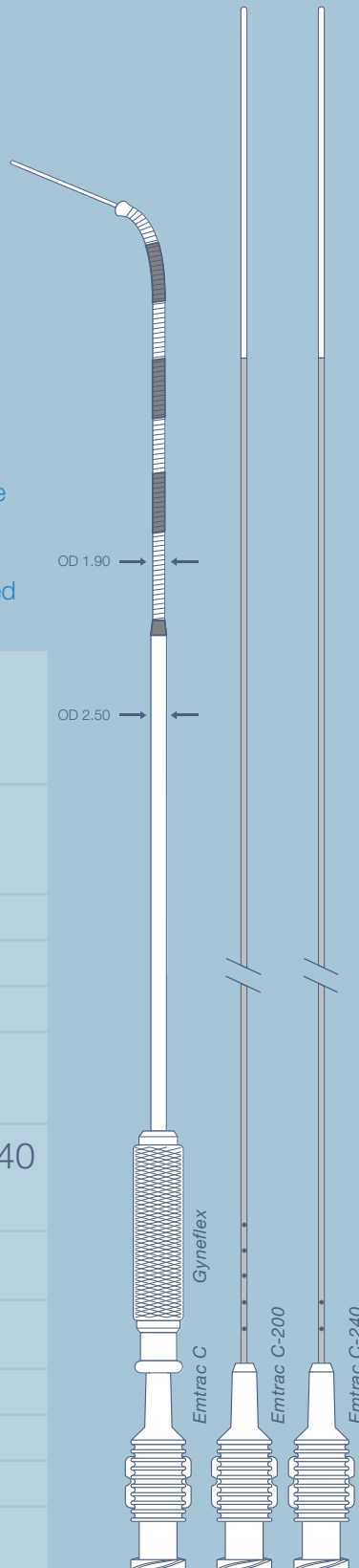

GMP Belgium Gyneflex 05/2013



Gynetics Medical Products n.v.  
Rembert Dodoensstraat 51 / 3920 Lommel, Belgium  
tel. +32 11 64 58 72 / fax +32 11 64 06 77  
info@gynetics.be / www.gynetics.be

**GYNETICS**<sup>®</sup>  
Practise better Medicine

# GYNO INFO

EMBRYO TRANSFER  
CATHETER RANGE ESPECIALLY  
DESIGNED FOR ULTRASOUND  
GUIDED PLACEMENT

ECHOGENIC EMBRYO TRANSFER CATHETER  
FOR EASY TRANSFER

PRODUCT	ORDER NUMBER
Semtrac Vision C	#2000 SV C

ECHOGENIC EMBRYO TRANSFER CATHETER SETS  
FOR DIFFICULT TRANSFER

PRODUCT	ORDER NUMBER
Semtrac Vision Set 4.2	#2000 SV Set 4.2
Semtrac Vision Set 5	#2000 SV Set 5
Semtrac Vision Set W-180	#2000 SV W-180
Semtrac Vision Set W-240	#2000 SV W-240

GMP Belgium Echogenic ET Range 04/2011



Gynetics Medical Products n.v.  
Rembert Dodoensstraat 51 / 3920 Lommel, Belgium  
tel. +32 11 64 58 72 / fax +32 11 64 06 77  
info@gynetics.be / www.gynetics.be

**GYNETICS**<sup>®</sup>  
Practise better Medicine

# SEMTRAC VISION C

## SOFT ECHOGENIC EMBRYO TRANSFER CATHETER

The Semtrac Vision C is a soft embryo transfer catheter, especially designed for ultrasound guided placement.

### FEATURES

- soft bullet shaped tip to minimize trauma
- individual microscopic quality inspection
- one piece economical catheter
- markings to indicate depth
- metal tube inside for better control
- handle with luer lock for a more secure fitting to syringes
- echogenic catheter for optimal visualisation during ultrasound guided transfers



ORIGINAL PICTURE

### GYNO INFO SEMTRAC VISION C

Length	252 mm (± 2 mm)
Tube OD	1.70 mm (± 0.05 mm)
Total volume	0.20 ml
Total volume minus hub	0.065 ml
Sterile	ETO sterilized
Packaging	75/shipping box
Quality control	MEA and LAL
Order number	#2000 SV C 



GMP Belgium Semtrac Vision C 04/2011



Gynetics Medical Products n.v.  
Rembert Dodoensstraat 51 / 3920 Lommel, Belgium  
tel. +32 11 64 58 72 / fax +32 11 64 06 77  
info@gynetics.be / www.gynetics.be

**GYNETICS**<sup>®</sup>  
Practise better Medicine

# SEMTRAC VISION SET 4.2

## SOFT ECHOGENIC EMBRYO TRANSFER CATHETER

The Semtrac Vision Set is a soft embryo transfer catheter set for difficult embryo transfers, especially designed for ultrasound guided placement.

### FEATURES

- soft bullet shaped tip to minimize trauma
- individual microscopic quality inspection
- three piece catheter for difficult transfers
- 5 free mandrels, to preshape the guiding catheter, in every box of 25 pieces
- reinforced shaft of loading catheter for optimal control
- handle with luer lock for a more secure fitting to syringes
- echogenic loading catheter for optimal visualisation during ultrasound guided transfers



ORIGINAL PICTURE

### GYNO INFO SEMTRAC VISION SET 4.2

Guiding catheter (A) length 158 mm ( $\pm$  2 mm)  
tube OD 2.55 mm ( $\pm$  0.05 mm)

Loading catheter (C) length 232 mm ( $\pm$  2 mm)  
tube OD 1.70 mm ( $\pm$  0.05 mm)  
total volume 0.23 ml  
total volume minus hub 0.081 ml

Sterile ETO sterilized

Packaging 75/shipping box

Quality control MEA and LAL

Order number #2000 SV Set 4.2 

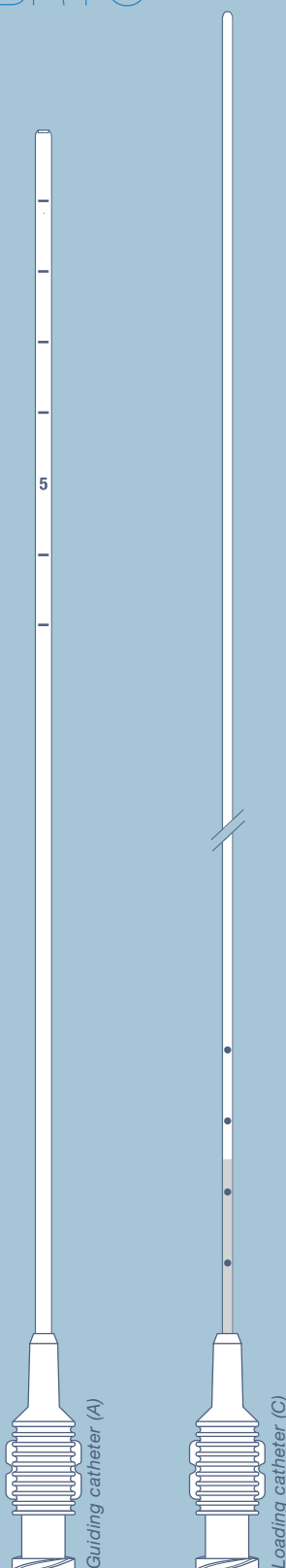

GMP Belgium Semtrac Vision Set 4.2 04/2011



Gynetics Medical Products n.v.  
Rembert Dodoensstraat 51 / 3920 Lommel, Belgium  
tel. +32 11 64 58 72 / fax +32 11 64 06 77  
info@gynetics.be / www.gynetics.be

**GYNETICS**<sup>®</sup>  
Practise better Medicine

# SEMTRAC VISION SET 5

## SOFT ECHOGENIC EMBRYO TRANSFER CATHETER

The Semtrac Vision Set is a soft embryo transfer catheter set for difficult embryo transfers, especially designed for ultrasound guided placement.

### FEATURES

- soft bullet shaped tip to minimize trauma
- individual microscopic quality inspection
- three piece catheter for difficult transfers
- 5 free mandrels, to preshape the guiding catheter, in every box of 25 pieces
- reinforced shaft of loading catheter for optimal control
- handle with luer lock for a more secure fitting to syringes
- echogenic loading catheter for optimal visualisation during ultrasound guided transfers

ORIGINAL PICTURE

### GYNO INFO SEMTRAC VISION SET 5

Guiding catheter (A) length 178 mm ( $\pm$  2 mm)  
tube OD 2.55 mm ( $\pm$  0.05 mm)

Loading catheter (C) length 252 mm ( $\pm$  2 mm)  
tube OD 1.70 mm ( $\pm$  0.05 mm)  
total volume 0.22 ml  
total volume minus hub 0.089 ml

Sterile ETO sterilized

Packaging 75/shipping box

Quality control MEA and LAL

Order number #2000 SV Set 5

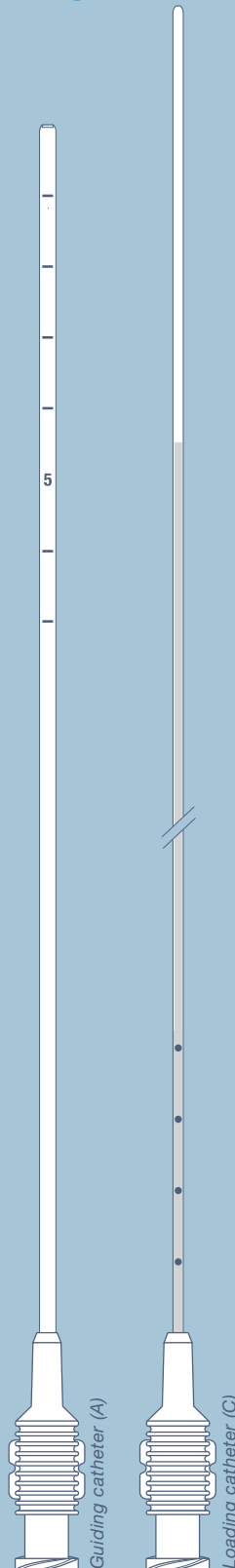

GMP Belgium Semtrac Vision Set 5 04/2011



Gynetics Medical Products n.v.  
Rembert Dodoensstraat 51 / 3920 Lommel, Belgium  
tel. +32 11 64 58 72 / fax +32 11 64 06 77  
info@gynetics.be / www.gynetics.be

**GYNETICS**<sup>®</sup>  
Practise better Medicine

# SEMTRAC VISION SET W-180

## SOFT ECHOGENIC EMBRYO TRANSFER CATHETER

The Semtrac Vision Set is a soft embryo transfer catheter set for difficult embryo transfers, especially designed for ultrasound guided placement.

### FEATURES

- soft bullet shaped tip to minimize trauma
- individual microscopic quality inspection
- 5 free mandrels, to preshape the guiding catheter, in every box of 25 pieces
- handle with luer lock for a more secure fitting to syringes
- echogenic loading catheter for optimal visualisation during ultrasound guided transfers



ORIGINAL PICTURE

### GYNO INFO SEMTRAC VISION SET W-180

Guiding catheter (A) length 141 mm ( $\pm$  2 mm)  
tube OD 2.55 mm ( $\pm$  0.05 mm)

Loading catheter (C) length 214 mm ( $\pm$  2 mm)  
tube OD 1.70 mm ( $\pm$  0.05 mm)  
total volume 0.23 ml  
total volume minus hub 0.074 ml

Sterile ETO sterilized

Packaging 75/shipping box

Quality control MEA and LAL

Order number #2000 SV W-180 ☒

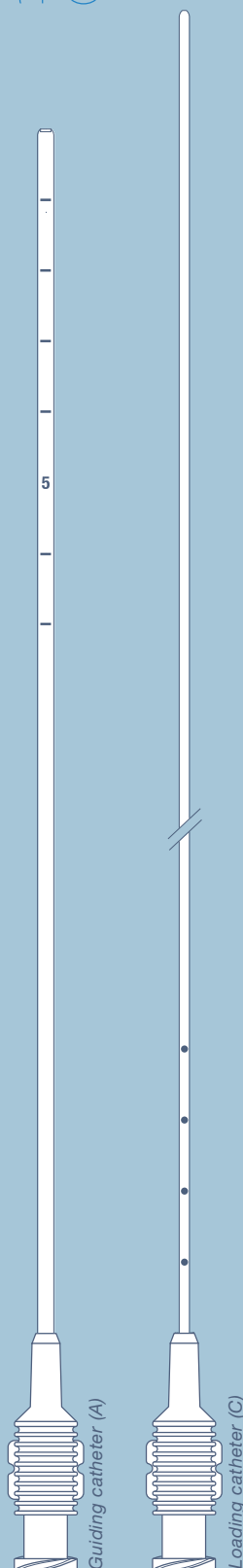

GMP Belgium Semtrac Vision W-180 04/2011



Gynetics Medical Products n.v.  
Rembert Dodoensstraat 51 / 3920 Lommel, Belgium  
tel. +32 11 64 58 72 / fax +32 11 64 06 77  
info@gynetics.be / www.gynetics.be

**GYNETICS**<sup>®</sup>  
Practise better Medicine



# SEMTRAC VISION SET W-240

## SOFT ECHOGENIC EMBRYO TRANSFER CATHETER

The Semtrac Vision Set is a soft embryo transfer catheter set for difficult embryo transfers, especially designed for ultrasound guided placement.

### FEATURES

- soft bullet shaped tip to minimize trauma
- individual microscopic quality inspection
- 5 free mandrels, to preshape the guiding catheter, in every box of 25 pieces
- handle with luer lock for a more secure fitting to syringes
- echogenic loading catheter for optimal visualisation during ultrasound guided transfers



ORIGINAL PICTURE

### GYNO INFO SEMTRAC VISION SET W-240

Guiding catheter (A) length 203 mm ( $\pm$  2 mm)  
tube OD 2.55 mm ( $\pm$  0.05 mm)

Loading catheter (C) length 277 mm ( $\pm$  2 mm)  
tube OD 1.70 mm ( $\pm$  0.05 mm)  
total volume 0.26 ml  
total volume minus hub 0.098 ml

Sterile ETO sterilized

Packaging 75/shipping box

Quality control MEA and LAL

Order number #2000 Semtrac SV W-240 

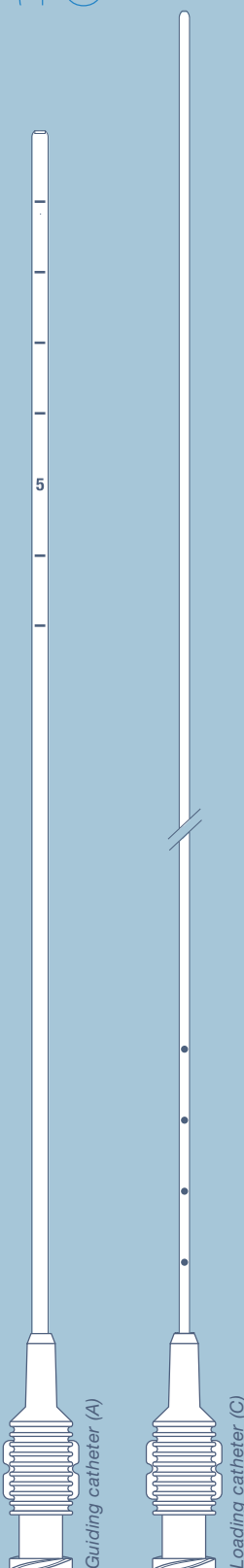

GMP Belgium Semtrac Vision W-240 04/2011



 Gynetics Medical Products n.v.  
Rembert Dodoensstraat 51 / 3920 Lommel, Belgium  
tel. +32 11 64 58 72 / fax +32 11 64 06 77  
info@gynetics.be / www.gynetics.be

**GYNETICS**<sup>®</sup>  
Practise better Medicine



# GYNO INFO

## PREMIUM FOLLICLE ASPIRATION NEEDLE RANGE

PRODUCT

ORDER NUMBER

Premium Follicle Aspiration Set Single Lumen	#4551 NS-AS1
	#4551 NS-BS1
	#4551 NS-CS1
	#4551 NS-DS1

GMP Belgium Premium Fas Range 05/2012

**GYNETICS**<sup>®</sup>  
Practise better Medicine



Gynetics Medical Products n.v.  
Rembert Dodoensstraat 51 / 3920 Lommel, Belgium  
tel. +32 11 64 58 72 / fax +32 11 64 06 77  
info@gynetics.be / www.gynetics.be

# PREMIUM FAS

## FOLLICLE ASPIRATION SET

The Premium FAS, the follicle aspiration set is implemented for ultrasound-guided, transvaginal harvesting of oocytes from follicles for IVF and ICSI.

### FEATURES

- standard follicle aspiration needle with regular tubing
- sharp lancet shaped needle ensures a clean facet cutting
- etched ultrasound markings on tip which offer stable and excellent vision during ultrasound
- translucent tubing in the same size as needle for safe oocyte retrieval
- arrow marking on handle for bevel point indication
- handle shape facilitates rotation



ORIGINAL PICTURE

### GYNO INFO PREMIUM FAS

Sterile	sterilized by radiation
Packaging	50/shipping box (standard configuration)
Quality control	MEA and LAL
Order number	<b>#4551 NS-AS1</b> ☒ <b>#4551 NS-BS1</b> ☒ <b>#4551 NS-CS1</b> ☒ <b>#4551 NS-DS1</b> ☒



GMP Belgium Premium Fas Set 12/2012



Gynetics Medical Products n.v.  
Rembert Dodoensstraat 51 / 3920 Lommel, Belgium  
tel. +32 11 64 58 72 / fax +32 11 64 06 77  
info@gynetics.be / www.gynetics.be

**GYNETICS**<sup>®</sup>  
Practise better Medicine

# GYNO INFO

## PREMIUM SINGLE LUMEN

① Order number	Gauge	OD/ID (mm)	Length (mm)	Working length (mm)	Control
#4551 NS-AS1	17.5G	1.4/1.2	400	350	Flexible
#4551 NS-BS1	17.5G	1.4/1.2	340	290	Flexible
#4551 NS-CS1	17.5G	1.4/1.0	400	350	Rigid
#4551 NS-DS1	17.5G	1.4/1.0	340	290	Rigid

Order number	Gauge	OD/ID (inch)	Length (inch)	Working length (inch)	Control
#4551 NS-AS1	17.5G	0.055/0.047	15.75	13.779	Flexible
#4551 NS-BS1	17.5G	0.055/0.047	13.39	11.417	Flexible
#4551 NS-CS1	17.5G	0.055/0.039	15.75	13.779	Rigid
#4551 NS-DS1	17.5G	0.055/0.039	13.39	11.417	Rigid

- ② Tube from needle to cork : Regular tubing 100 cm / 39.369 inch
- ③ Size silicon cork : Small 14 x 18 x 20 mm / 0.551 x 0.709 x 0.787 inch
- ④ Tube from cork to pump : Regular tubing 100 cm / 39.369 inch

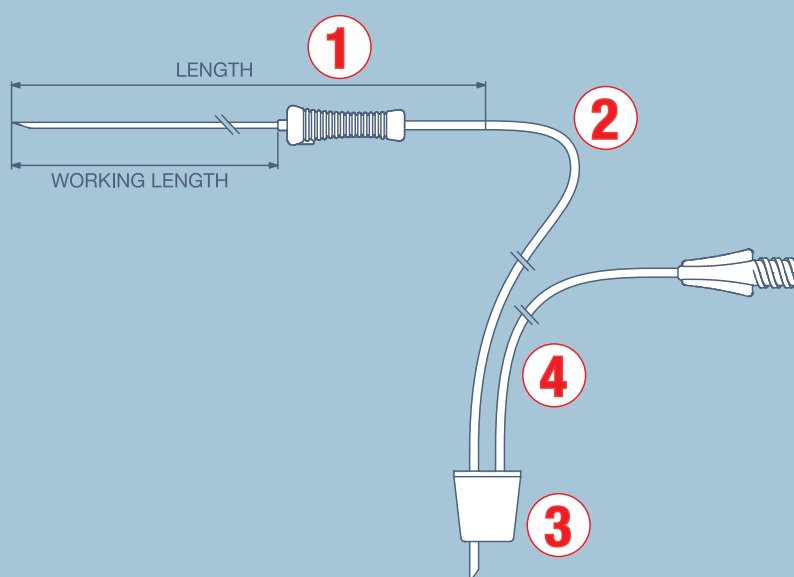

# GYNETICS®

Practise better Medicine



# GYNO INFO

## SUPERIOR FOLLICLE ASPIRATION NEEDLE RANGE

### PRODUCT

Custom-made Superior Follicle Aspiration Set Single Lumen

Custom-made Superior Follicle Aspiration Set Single Lumen Flush

Custom-made Superior Follicle Aspiration Set Double Lumen Flush

GMP Belgium Superior Fas Range 06/2013



Gynetics Medical Products n.v.  
Rembert Dodoensstraat 51 / 3920 Lommel, Belgium  
tel. +32 11 64 58 72 / fax +32 11 64 06 77  
info@gynetics.be / www.gynetics.be

**GYNETICS**<sup>®</sup>  
Practise better Medicine

# SUPERIOR FAS

## FOLLICLE ASPIRATION SET FEATURES & ACCESSORIES

### NEEDLE TYPES

3 needle types, available in various sizes and dimensions to determine your own specification:

Single Lumen      Single Lumen Flush      Double Lumen Flush

### NEEDLE TIPS

2 types of needle tips to guarantee clean facet cutting:

Back Cut Bevel



Lancet Bevel



### TIP MARKINGS

2 types of tip markings to offer excellent ultrasound visibility of the needle tip:

Dual Laser Marking



Embossed Marking



### HANDLES

2 types of handles (only for single lumen flush & double lumen flush):

U shaped handle

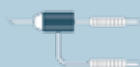

Y shaped handle



### TRANSLUCENT TUBING

3 types of translucent tubing in any desired length (maximum length thick wall tubing is 120cm / 47.2 inch):

Regular Tubing

Soft Tubing

allows control of the fluid

Thick Wall Tubing

no kinking of the tubing

### CORKS

2 types of corks:

Small

14x18x20 mm

0.55 x 0.71 x 0.79 inch



Medium

21 x 27x30 mm

0.83 x 1.06 x 1.18 inch

### ACCESSORIES - SPECIALS

3-way Valve



Male/male Connector



Luer Lock Needle (For direct connection to a syringe)



Contact us for other or special enquiries!



# SUPERIOR FAS

## CUSTOM-MADE FOLLICLE ASPIRATION SET

The Superior FAS, the follicle aspiration set is implemented for ultrasound-guided, transvaginal harvesting of oocytes from follicles for IVF and ICSI.

### FEATURES

- sharp lancet or back cut bevel shaped needle ensures a clean facet cutting
- dual laser or embossed echogenic marked tip offers stable and excellent vision during ultrasound
- various needle sizes for ovaries with complicated and/or limited access
- translucent tubing in the same size as needle for safe oocyte retrieval
- arrow marking on handle for bevel point indication
- handle shape facilitates rotation
- custom-made



ORIGINAL PICTURE

### GYNO INFO SUPERIOR FAS

Sterile	sterilized by radiation
Packaging	50/shipping box (standard configuration)
Quality control	MEA and LAL
Order number	#4551 ②

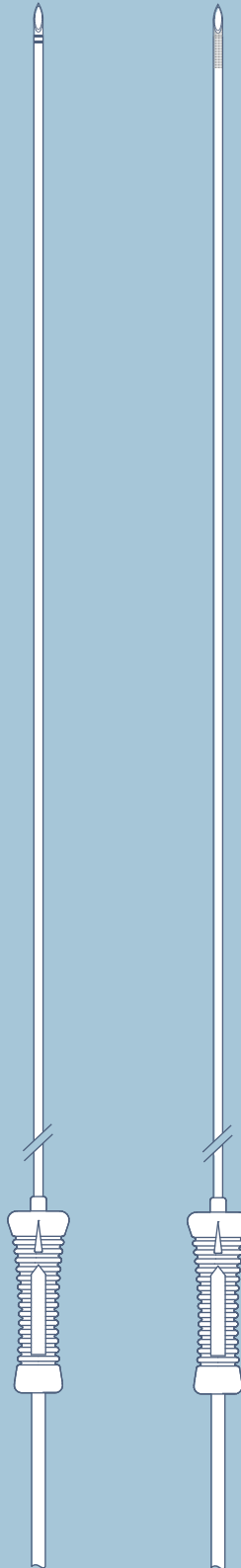

Gynetics Medical Products n.v.  
Rembert Dodoensstraat 51 / 3920 Lommel, Belgium  
tel. +32 11 64 58 72 / fax +32 11 64 06 77  
info@gynetics.be / www.gynetics.be

**GYNETICS**<sup>®</sup>  
Practise better Medicine



# SUPERIOR FAS

## CONFIGURE YOUR OWN CUSTOM-MADE SUPERIOR FOLLICLE ASPIRATION SET IN 6 STEPS

COPY OR DOWNLOAD AT [WWW.GYNETICS.BE](http://WWW.GYNETICS.BE), COMPLETE AND RETURN FOR INQUIRY

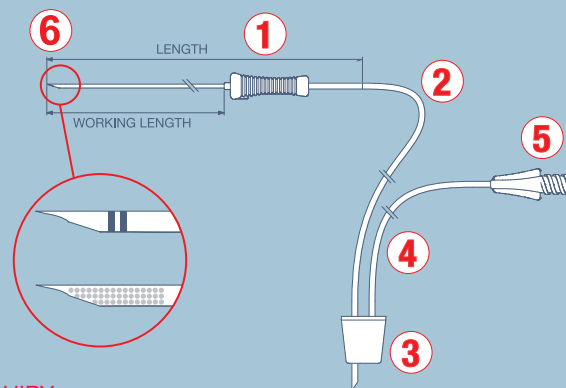

### STEP 1 CHOOSE YOUR NEEDLE

TICK BOX

Gauge	OD/ID (mm)	OD/ID (inch)	Length (mm)	Length (inch)	Control	
16G	1.6/1.3	0.063/0.051	400	15.75	Medium	<input type="checkbox"/>
16G	1.6/1.3	0.063/0.051	340	13.39	Medium	<input type="checkbox"/>
16G	1.6/1.1	0.063/0.043	400	15.75	Super rigid	<input type="checkbox"/>
17G	1.5/0.9	0.059/0.035	350	13.78	Super rigid	<input type="checkbox"/>
17G	1.5/0.9	0.059/0.035	400	15.75	Super rigid	<input type="checkbox"/>
17.5G	1.4/1.2	0.055/0.047	400	15.75	Flexible	<input type="checkbox"/>
17.5G	1.4/1.2	0.055/0.047	340	13.39	Flexible	<input type="checkbox"/>
17.5G	1.4/1.0	0.055/0.039	400	15.75	Rigid	<input type="checkbox"/>
17.5G	1.4/1.0	0.055/0.039	330	12.99	Rigid	<input type="checkbox"/>
17.5G	1.4/1.0	0.055/0.039	350	13.78	Rigid	<input type="checkbox"/>
18G	1.2/1.0	0.047/0.039	350	13.78	Medium	<input type="checkbox"/>
19G	1.0/0.65	0.039/0.026	330	12.99	Medium	<input type="checkbox"/>
20G	0.9/0.65	0.035/0.026	370	14.57	Medium	<input type="checkbox"/>

The working length of each needle is the length minus 50 mm/1.968 inch

### STEP 2 CHOOSE YOUR TUBING FROM NEEDLE TO CORK

Type	Length needed	Remarks	
Regular Tubing	_____ cm/inch	n/a	<input type="checkbox"/>
Soft Tubing	_____ cm/inch	n/a	<input type="checkbox"/>
Thick Wall Tubing	_____ cm/inch	max. 120 cm/47.2 inch	<input type="checkbox"/>
Female Luer Connector at end of needle			<input type="checkbox"/>

### STEP 3 SILICON CORK

Type	Size (mm)	Size (inch)	
Small Cork	14 x 18 x 20	0.55 x 0.71 x 0.79	<input type="checkbox"/>
Medium Cork	21 x 27 x 30	0.83 x 1.06 x 1.18	<input type="checkbox"/>





### STEP 4 CHOOSE YOUR TUBING FROM CORK TO PUMP

Type	Length needed	Remarks	
Regular Tubing	_____ cm/inch	n/a	<input type="checkbox"/>
Soft Tubing	_____ cm/inch	n/a	<input type="checkbox"/>
Thick Wall Tubing	_____ cm/inch	max. 120 cm/47.2 inch	<input type="checkbox"/>

### STEP 5 CHOOSE YOUR CONNECTION TO THE PUMP

Female Luer Connector (standard)	<input type="checkbox"/>
Male Luer Connector	<input type="checkbox"/>
No Connector	<input type="checkbox"/>

### STEP 6 CHOOSE YOUR VARIATION OF THE TIP

Back Cut Bevel	 <input type="checkbox"/>	 <input type="checkbox"/>
Lancet Bevel	 <input type="checkbox"/>	 <input type="checkbox"/>
	Dual Laser Marking	Embossed Marking



Gynetics Medical Products n.v.  
Rembert Dodoensstraat 51 / 3920 Lommel, Belgium  
tel. +32 11 64 58 72 / fax +32 11 64 06 77  
info@gynetics.be / www.gynetics.be

**GYNETICS**<sup>®</sup>  
Practise better Medicine



# SUPERIOR FAS

## CUSTOM-MADE FOLLICLE ASPIRATION SET DOUBLE AND SINGLE LUMEN FLUSH

The Superior FAS, the follicle aspiration set is implemented for ultrasound-guided, transvaginal harvesting of oocytes from follicles for IVF and ICSI.

### FEATURES

- flushing connector enables flushing during complicated oocyte retrieval or when few mature oocytes occur
- dual laser marked or embossed echogenic tip offers stable and excellent vision during ultrasound
- translucent tubing in the same size as needle for safe oocyte retrieval
- various needle sizes for ovaries with complicated and/or limited access
- arrow marking on handle for bevel point indication
- handle shape facilitates rotation
- custom-made



ORIGINAL PICTURE

### GYNO INFO SUPERIOR FAS

Sterile	sterilized by radiation
Packaging	50/shipping box (standard configuration)
Quality control	MEA and LAL
Order number	<b>#4551</b> 

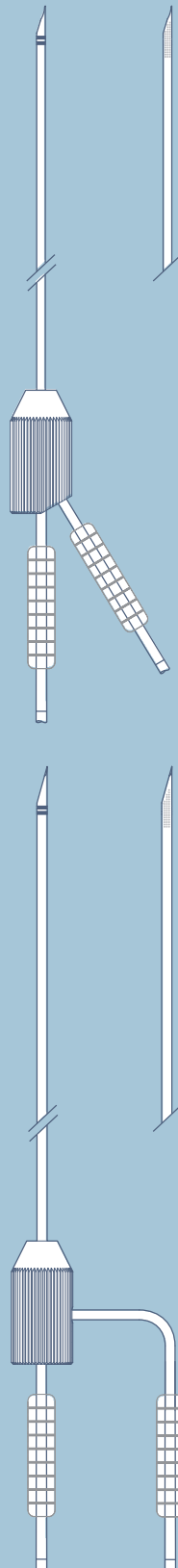

Gynetics Medical Products n.v.  
Rembert Dodoensstraat 51 / 3920 Lommel, Belgium  
tel. +32 11 64 58 72 / fax +32 11 64 06 77  
info@gynetics.be / www.gynetics.be

**GYNETICS**<sup>®</sup>  
Practise better Medicine

# SUPERIOR FAS

CONFIGURE YOUR OWN CUSTOM-MADE SUPERIOR FOLLICLE ASPIRATION SET IN 7 STEPS

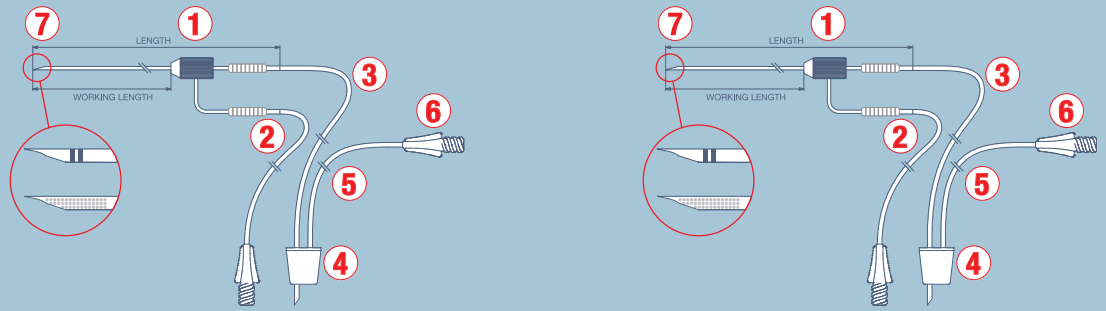

COPY OR DOWNLOAD AT [WWW.GYNETICS.BE](http://WWW.GYNETICS.BE), COMPLETE AND RETURN FOR INQUIRY

## STEP 1 CHOOSE YOUR FLUSH NEEDLE

TICK BOX  Control

Needle Lumen	Gauge	OD/ID (mm)	OD/ID (inch)	Length (mm)	Length (inch)		
Double	16G	outer lumen 1.65/1.40 inner lumen 1.20/1.00	0.065/0.055 0.047/0.039	352	13.858	Rigid	<input type="checkbox"/>
Double	17G	outer lumen 1.50/1.20 inner lumen 1.00/0.80	0.059/0.047 0.039/0.032	352	13.858	Rigid	<input type="checkbox"/>
Single	17.5G	1.40/1.20	0.055/0.047	352	13.858	Flexible	<input type="checkbox"/>
Single	17.5G	1.40/1.00	0.055/0.039	352	13.858	Rigid	<input type="checkbox"/>

The working length of each needle is 300 mm/11.811 inch



## STEP 2 CHOOSE YOUR FLUSH TUBING

Tubing	Length needed	Remarks	
Regular Tubing	_____ cm/inch	n/a	<input type="checkbox"/>
Soft Tubing	_____ cm/inch	n/a	<input type="checkbox"/>
Thick Wall Tubing	_____ cm/inch	max. 120 cm/47.2 inch	<input type="checkbox"/>

## STEP 3 CHOOSE YOUR TUBING FROM NEEDLE TO CORK

Tubing	Length needed	Remarks	
Regular Tubing	_____ cm/inch	n/a	<input type="checkbox"/>
Soft Tubing	_____ cm/inch	n/a	<input type="checkbox"/>
Thick Wall Tubing	_____ cm/inch	max. 120 cm/47.2 inch	<input type="checkbox"/>

## STEP 4 SILICON CORK

Type	Size (mm)	Size (inch)	
Small Cork	14 x 18 x 20	0.55 x 0.71 x 0.79	<input type="checkbox"/>
Medium Cork	21 x 27 x 30	0.83 x 1.06 x 1.18	<input type="checkbox"/>

## STEP 5 CHOOSE YOUR TUBING FROM CORK TO PUMP

Type	Length needed	Remarks	
Regular Tubing	_____ cm/inch	n/a	<input type="checkbox"/>
Soft Tubing	_____ cm/inch	n/a	<input type="checkbox"/>
Thick Wall Tubing	_____ cm/inch	max. 120 cm/47.2 inch	<input type="checkbox"/>

## STEP 6 CHOOSE YOUR CONNECTION TO THE PUMP

Female Luer Connector (standard)	<input type="checkbox"/>
Male Luer Connector	<input type="checkbox"/>
No Connector	<input type="checkbox"/>

## STEP 7 CHOOSE YOUR VARIATION OF THE TIP



# GYNO INFO

## CUSTOM-MADE SUPERIOR FLUSH NEEDLES

### DOUBLE LUMEN FLUSH

Gauge	OD/ID (mm)	Length (mm)	Working length (mm)	Control
16G	outer lumen 1.65/1.40 inner lumen 1.20/1.00	352	300	Rigid
17G	outer lumen 1.50/1.20 inner lumen 1.00/0.80	352	300	Rigid

Gauge	OD/ID (inch)	Length (inch)	Working length (inch)	Control
16G	outer lumen 0.065/0.055 inner lumen 0.047/0.039	13.858	11.811	Rigid
17G	outer lumen 0.059/0.047 inner lumen 0.039/0.032	13.858	11.811	Rigid

### SINGLE LUMEN FLUSH

Gauge	OD/ID (mm)	Length (mm)	Working length (mm)	Control
17.5G	1.40/1.20	352	300	Flexible
17.5G	1.40/1.00	352	300	Rigid

Gauge	OD/ID (inch)	Length (inch)	Working length (inch)	Control
17.5G	0.055/0.047	13.858	11.811	Flexible
17.5G	0.055/0.039	13.858	11.811	Rigid



# GYNO INFO

## SAMPLING / LABORATORY / MISCELLANEOUS / IUD RANGE

PRODUCT	ORDER NUMBER
Detecta	#4163
Probet	#4164
In/out	#4165
Echosampler	#5164
Hysterometer	#4171-10 #4171-12 #4171-14
Curette	#4168 AG-4 #4168 AG-6 #4168 AG-8
Handling Pipette	#3145      #3145 TP #3100      #3100 TP #3125      #3125 TP
Denuding Pipette Strip-ID	#3000 Strip-ID125/10 #3000 Strip-ID130/10 #3000 Strip-ID135/10 #3000 Strip-ID140/10 #3000 Strip-ID145/10 #3000 Strip-ID150/10 #3000 Strip-ID170/10 #3000 Strip-ID175/10 #3000 Strip-ID200/10 #3000 Strip-ID275/10
IUD Cu250 Luxe	#9940-250
IUD Cu375 Luxe	#9940-375
IUD Sof-T Luxe	#9950

GMP Belgium Sampling/Iud/Laboratory/Miscellaneous 06/2013



Gynetics Medical Products n.v.  
Rembert Dodoensstraat 51 / 3920 Lommel, Belgium  
tel. +32 11 64 58 72 / fax +32 11 64 06 77  
info@gynetics.be / www.gynetics.be

**GYNETICS**<sup>®</sup>  
Practise better Medicine

# DETECTA

## CERVICAL SCREENING DEVICE DESIGNED TO OBTAIN OPTIMAL SAMPLES

The Detecta is a simple but efficient cervical sampling device.

### FEATURES

- allows in-office sampling
- systematic brushing of the transitional zone
- helps to detect neoplasia at an early stage
- easy to handle



ORIGINAL PICTURE

### GYNO INFO DETECTA

Length	194 mm
Packaging	1250/shipping box
Order number	#4163 ☒

GMP Belgium Detecta 06/09



Gynetics Medical Products n.v.  
Rembert Dodoensstraat 51 / 3920 Lommel, Belgium  
tel. +32 11 64 58 72 / fax +32 11 64 06 77  
info@gynetics.be / www.gynetics.be

**GYNETICS**<sup>®</sup>  
Practise better Medicine

# MANUAL DETECTA

- gently insert the Detecta into the cervix
- rotate only once to obtain the sample
- gently withdraw the Detecta without rotating
- smear sample on a slide with one rotation of the Detecta
- fixate the slide immediately
- sample is ready for examination

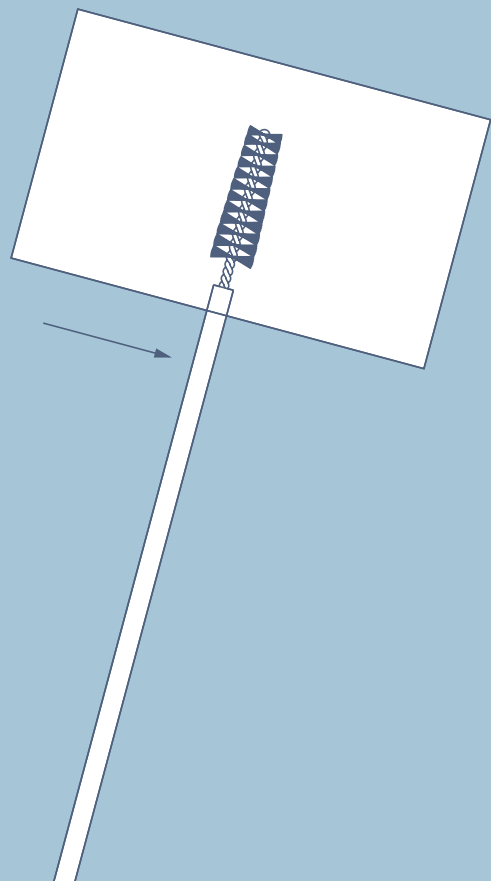
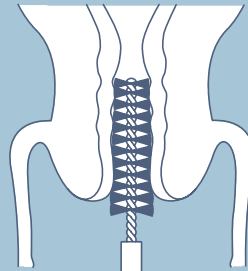

# PROBET

## ENDOMETRIAL HISTOLOGY

The Probet is an endometrial suction curette for a histologic lining biopsy.

### FEATURES

- double headed piston secures a steady vacuum
- tissue collection through side hole
- smooth rounded distal tip and small size for minimal patient discomfort
- depth markings for ease in locating depth of insertion in the uterus



ORIGINAL PICTURE

### GYNO INFO PROBET

Length	262 mm (± 3 mm)
Tube OD	2.93 mm (± 0.03 mm)
Sterile	ETO sterilized
Packaging	75/shipping box
Order number	#4164 



GMP Belgium Probet 04/2011



Gynetics Medical Products n.v.  
Rembert Dodoensstraat 51 / 3920 Lommel, Belgium  
tel. +32 11 64 58 72 / fax +32 11 64 06 77  
info@gynetics.be / www.gynetics.be

**GYNETICS**<sup>®</sup>  
Practise better Medicine

# MANUAL PROBET

1) Insert Probet through cervical canal while piston is fully engaged in outer tube ("sheath") until wall contact is felt, taking into account hystero-metry and curvature.

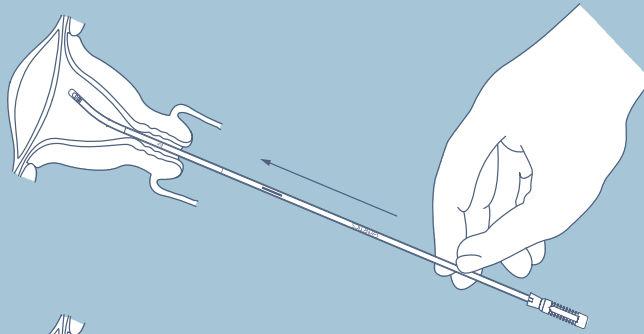

2) Hold sheath. Pull piston back completely until stopper is reached, in order to create maximum negative pressure within sheath.

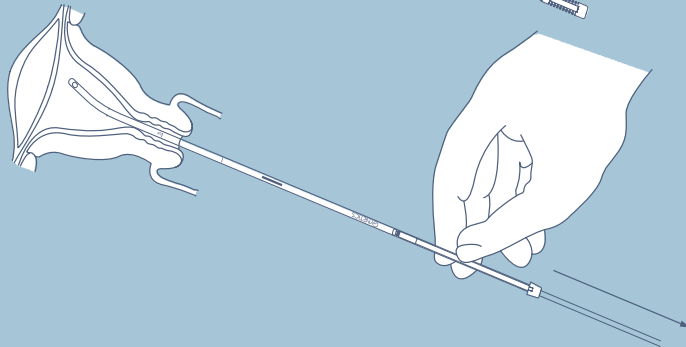

3) Roll sheath between fingers 4 times – while simultaneously moving it back and forth inside the uterus – for comprehensive sampling.

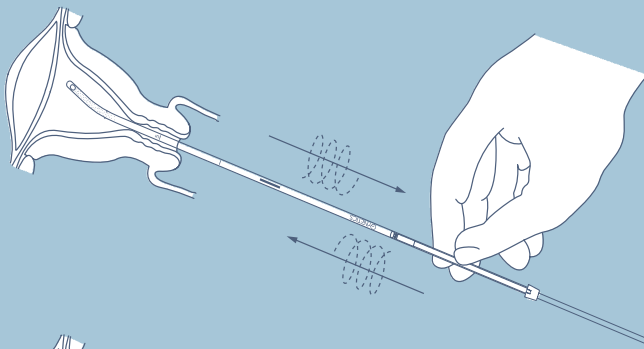

4) Remove device. Cut distal tip just below side opening. Push piston back into sheath to expell sample in transport medium.

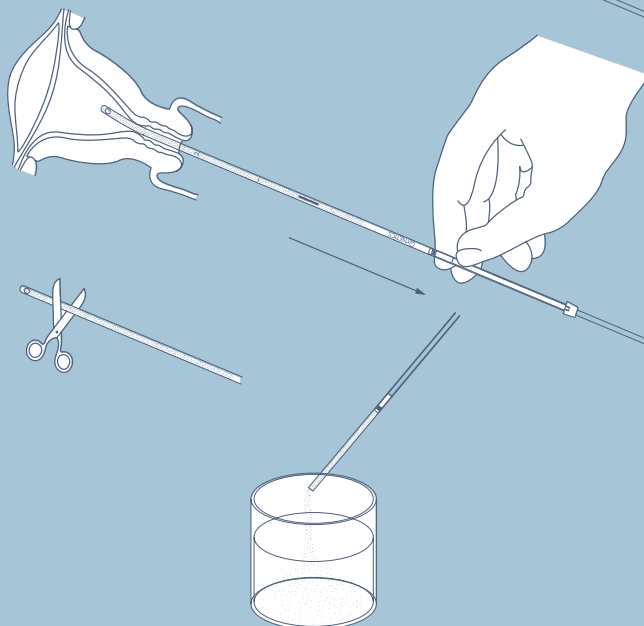



# IN/OUT

## ENDOMETRIAL HISTOLOGY

The IN/OUT is an endometrial suction curette for a histologic lining biopsy.

### FEATURES

- double headed piston secures a steady vacuum
- tissue collection through the tip
- smooth rounded distal tip and small size for minimal patient discomfort
- depth markings for ease in locating depth of insertion in the uterus



ORIGINAL PICTURE

### GYNO INFO IN/OUT

Length	262 mm (± 3 mm)
Tube OD	2.93 mm (± 0.03 mm)
Sterile	ETO sterilized
Packaging	75/shipping box
Order number	<b>#4165</b> 



GMP Belgium IN/OUT 04/2011



Gynetics Medical Products n.v.  
Rembert Dodoensstraat 51 / 3920 Lommel, Belgium  
tel. +32 11 64 58 72 / fax +32 11 64 06 77  
info@gynetics.be / www.gynetics.be

**GYNETICS**<sup>®</sup>  
Practise better Medicine

# MANUAL IN /OUT

1) Insert In/out through cervical canal while piston is fully engaged in outer tube ('sheath') until wall contact is felt, taking into account hysteroemetry and curvature.

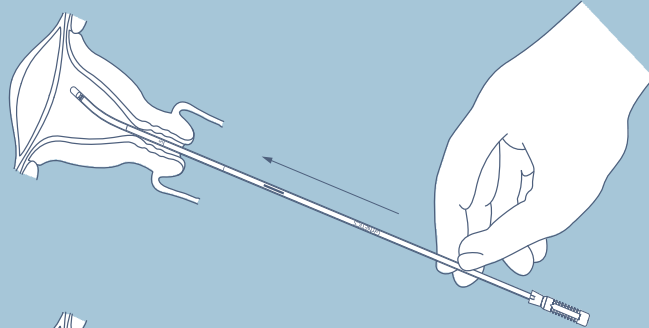

2) Hold sheath. Pull piston back completely until stopper is reached, in order to create maximum negative pressure within sheath.

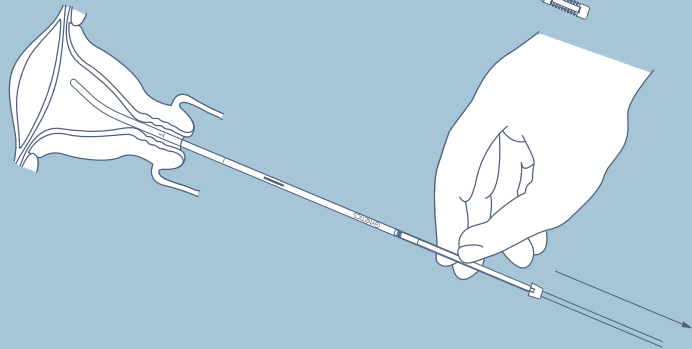

3) Roll sheath between fingers 4 times – while simultaneously moving it back and forth inside the uterus – for comprehensive sampling.

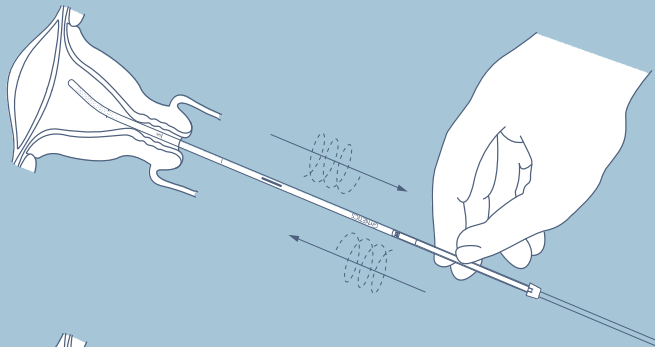

4) Remove device. Push piston back into sheath to expell sample in transport medium.

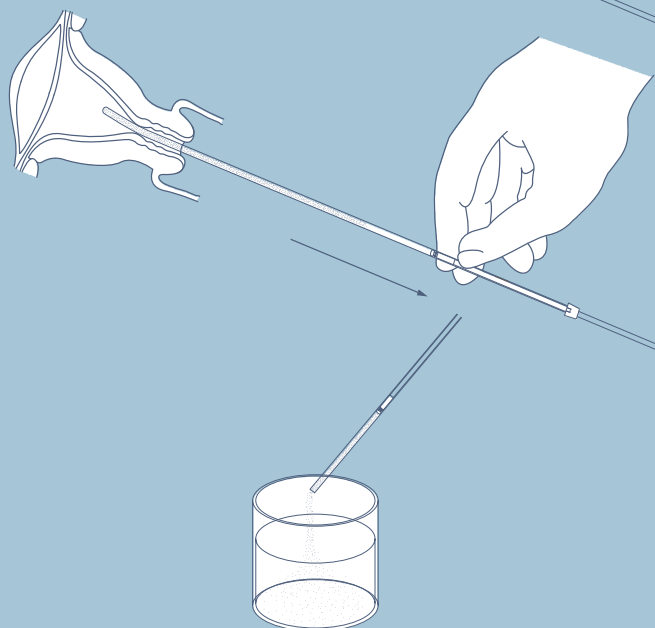

# ECHOSAMPLER

## INTRACAVITAL PATHOLOGY AND ENDOMETRIAL HISTOLOGY

The EchoSampler is a flexible sampling catheter used for dual diagnosis: intracavitary pathology and endometrial histology.

### FEATURES

- flexible sampling catheter
- for ultrasound guided biopsy
- for saline infusion sonohysterography
- implemented in case of abnormal uterine bleeding
- dual diagnoses: cavital pathology and endometrial histology



ORIGINAL PICTURE

### GYNÔ INFO ECHOSAMPLER

Length	180 mm ( $\pm$ 3 mm)
Tube OD	2.93 mm ( $\pm$ 0.04 mm)
Sterile	ETO sterilized
Packaging	75/shipping box
Order number	#5164 ☒

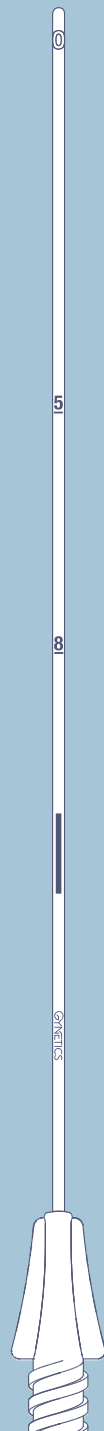

GMP Belgium Echosampler 04/2011



# HYSTEROMETER

## A DEVICE TO ASSESS THE TOTAL UTERINE DEPTH

The Hysterometer is a device for preliminary hysteroemetry.

### FEATURES

- three sizes: 10, 12, 14
- 14 depth markings from distal tip
- flexible
- smooth rounded tip for easy insertion

ORIGINAL PICTURE

### GYNO INFO HYSTEROMETER

Length 10	286 mm
Length 12	281 mm
Length 14	287 mm

Sterile	ETO sterilized
---------	----------------

Packaging	75/shipping box
-----------	-----------------

Order number	#4171-10 ☺
	#4171-12 ☺
	#4171-14 ☺



GMP Belgium Hysterometer 09/2012



Gynetics Medical Products n.v.  
Rembert Dodoensstraat 51 / 3920 Lommel, Belgium  
tel. +32 11 64 58 72 / fax +32 11 64 06 77  
info@gynetics.be / www.gynetics.be

**GYNETICS**<sup>®</sup>  
Practise better Medicine

# CURETTE

## ASPIRATION CURETTE WITH STANDARD FITTING

The Curette is a green, disposable, aspiration curette with standard fitting.

### FEATURES

- standard fitting for easy use
- connector and curette moulded in one piece
- safer use, as a result of exclusion of resterilisation risks
- economical, no resterilization costs
- made from flexible material
- three sizes: 4, 6, 8



ORIGINAL PICTURE

### GYNO INFO CURETTE

Sterile	ETO sterilized
Packaging	125/shipping box
Order number	#4168 AG-4 ☒ #4168 AG-6 ☒ #4168 AG-8 ☒

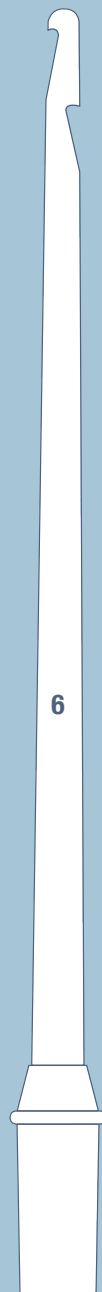

GMP Belgium Curette 06/2010



Gynetics Medical Products n.v.  
Rembert Dodoensstraat 51 / 3920 Lommel, Belgium  
tel. +32 11 64 58 72 / fax +32 11 64 06 77  
info@gynetics.be / www.gynetics.be

**GYNETICS**<sup>®</sup>  
Practise better Medicine

# HANDLING PIPETTE

## MICROTOOL FOR TRANSFERRING EMBRYOS AND OOCYTES

The handling pipette is a microtool used for transferring oocytes and embryos from one dish to another.

### FEATURES

- laboratory microtool for dish-to-dish transfer of oocytes and embryos
- will not scratch dishes
- available in three lengths: 45, 55 and 94 mm
- available in two packaging variations: single packed and packed by ten pieces

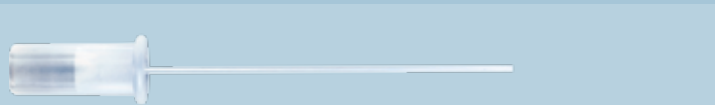

ORIGINAL PICTURE

### GYNO INFO HANDLING PIPETTE

Length 45, 55 or 94 mm ( $\pm 3$  mm)

Tube OD 1.25 mm ( $\pm 0.05$  mm)

Tube ID 1.00 mm ( $\pm 0.05$  mm)

Sterile sterilized by radiation

Packaging 250/shipping box  
1250/shipping box (10/pouch)

Quality control MEA and LAL

Order number **#3145** ☉ (45 mm)  
**#3100** ☉ (55 mm)  
**#3125** ☉ (94 mm)  
**#3145 TP** ☉ (45 mm, 10/pouch)  
**#3100 TP** ☉ (55 mm, 10/pouch)  
**#3125 TP** ☉ (94 mm, 10/pouch)

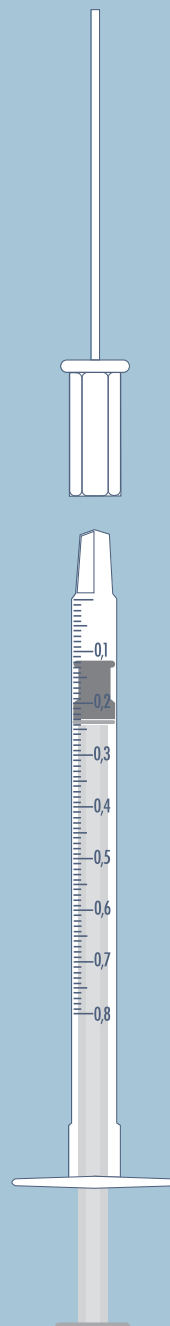

GMP Belgium Handling Pipette 04/2011

# STRIP-ID125-275

## MICROTOOL FOR DENUDATION OF EMBRYOS AND OOCYTES

The denuding pipette Strip-ID is a single-use laboratory microtool used for denuding of embryos and oocytes

### FEATURES











- superior quality that ensures smooth edges for precise denudation
- strict individual microscopic quality inspection
- flexible, unbreakable design that will not scratch dishes
- convenient multi-packaging that allows easy removal of a single pipette
- various sizes available to suit your needs
- compatible design to fit most commonly used pipette holders

ORIGINAL PICTURE



ORIG. PIC. 200X  
ENLARGED

### GYNO INFO STRIP-ID

Length	90 mm ( $\pm$ 3 mm)	
Inner diameter $\mu$ m	125 $\mu$ m (+ 3 $\mu$ m) 130 $\mu$ m (+ 3 $\mu$ m) 135 $\mu$ m (+ 3 $\mu$ m) 140 $\mu$ m (+ 3 $\mu$ m) 145 $\mu$ m (+ 3 $\mu$ m)	150 $\mu$ m (+ 3 $\mu$ m) 170 $\mu$ m (+ 3 $\mu$ m) 175 $\mu$ m (+ 3 $\mu$ m) 200 $\mu$ m (+ 3 $\mu$ m) 275 $\mu$ m (+ 3 $\mu$ m)
Sterile	sterilized by radiation	
Packaging	10 tips / tube 5 tubes / inner box 25 tubes of 10 tips / shipping box	
Quality control	MEA and LAL	
Order number	#3000 Strip-ID125/10  (125 $\mu$ m) #3000 Strip-ID130/10  (130 $\mu$ m) #3000 Strip-ID135/10  (135 $\mu$ m) #3000 Strip-ID140/10  (140 $\mu$ m) #3000 Strip-ID145/10  (145 $\mu$ m) #3000 Strip-ID150/10  (150 $\mu$ m) #3000 Strip-ID170/10  (170 $\mu$ m) #3000 Strip-ID175/10  (175 $\mu$ m) #3000 Strip-ID200/10  (200 $\mu$ m) #3000 Strip-ID275/10  (275 $\mu$ m)	

GMP Belgium Denuding Pipette Strip-ID 06/2013



Gynetics Medical Products n.v.  
Rembert Dodoensstraat 51 / 3920 Lommel, Belgium  
tel. +32 11 64 58 72 / fax +32 11 64 06 77  
info@gynetics.be / www.gynetics.be

**GYNETICS**<sup>®</sup>  
Practise better Medicine

# INTRAUTERINE CONTRACEPTIVE DEVICES

Gynétics CU 250

Gynétics CU 375

SOF-T<sup>®</sup> CU 375



Gynétics Medical Products n.v.  
Rembert Dodoensstraat 51 / 3920 Lommel, Belgium  
tel. +32 11 64 58 72 / fax +32 11 64 06 77  
info@gynetics.be / www.gynetics.be

**GYNETICS**<sup>®</sup>  
Practise better Medicine



Gynetics Medical Products N.V. is a corporation under Belgian law. The company was founded in the year 1972. At first, our activities were in Family Planning. We invented a range of intrauterine contraceptive devices.

In the meantime we became involved in Human Assisted Reproduction Technology. We developed several devices and instruments that are sold world-wide. We are well introduced in this field and intend to continue to be active therein for many years to come.

Gynetics offers a wide range of different technologies and types. Currently we are offering Cu-IUDs, whose effectiveness has been proven in international studies over a long period of time.

**Gynetics CU 250 (ETO sterilized)**

The Gynetics CU 250 IUD is made of polyethylene. The stem is covered with a special copper wire where the total surface of the copper amounts to 250 square mm.

**Gynetics CU 375 (ETO sterilized)**

It offers the same advantages as the Gynetics CU 250, but due to the greater copper surface (375 square mm) the utilisation period is longer.

All Gynetics products are manufactured from biocompatible materials, suitable for human-assisted reproduction. Assembled in a clean room, the products are subjected to stringent testing and the highest Quality assurance procedures conform CE directive 93/42/EEG. Gynetics is ISO 9001 and ISO 13485 certified. All products that are used to assist in the reproduction process are gamma-irradiated or ETO sterilized.

Although fully independent, Gynetics has important connections to major companies in the health industry. Gynetics implements research, development and manufacturing of new products on behalf of innovators and leaders in the field of gynaecology and obstetrics.

